



Multilift

Vertical Platform Lift



OWNER'S MANUAL

(To Be Retained by Owner After Installation
by Authorized Savaria Dealer)

Part No. 000609
29-m08-2018

IMPORTANT

Ensure that only an authorized Savaria Dealer installs and services the Savaria™ Multilift Vertical Platform Lift. Under no circumstances is anyone other than a dealer with Savaria training and authorization to install, adjust, service or modify any mechanical or electrical device on this equipment. Failure to follow this warning can result in safety system compromises or defeat; this can result in serious injury or death. Savaria accepts no liability for property damage, warranty claims or personal injury, including death, in this circumstance.

Passenger safety is the result of countless details in the equipment’s design, manufacture, and installation. After installation, reliable operation and continual safe operation requires regular service and inspection at least twice per year, or more frequently where usage, environment, or local jurisdiction requires. As the Owner, you are responsible for ensuring that regular service and inspections occur in a timely manner.

Refer to this manual for specifications, operating instructions and maintenance of the Savaria™ Multilift Vertical Platform Lift.

Upon completion of installation, the dealer must provide you with the following information and ensure it is recorded in this manual. In addition, either the dealer or you must keep any service and/or maintenance records in the Maintenance Record section of this manual.

WARRANTY

Ensure your Savaria Dealer provides you with a copy of the manufacturer’s limited parts warranty and documentation relating to any Dealer labour warranty.

<p style="text-align: center;">FOR OWNER’S RECORDS</p> <p>Customer Name: _____</p> <p>Installing Dealer: _____</p> <p>Dealer’s Telephone Number: _____</p> <p>Date Installed: _____</p> <p>Serial/Job Number: _____</p>
--

TABLE OF CONTENTS

TO ENSURE SAFE OPERATION	3
1. DESCRIPTION	4
2. GENERAL SPECIFICATIONS	5
3. OPERATION	6
Attendant Operation.....	7
Operating from the COP Controls	8
Operating from the Landing Station Controls	7
4. ADDITIONAL FEATURES	8
Platform Gate	8
Safety Underpan	8
Door Locks	9
Emergency Stop Button	11
Manual Lowering Device	11
5. MAINTENANCE	12
Maintenance Schedule	12
Maintenance Record	14
Operator Troubleshooting	15

TO ENSURE SAFE OPERATION

To ensure safe operation of this equipment, pay careful attention to the important notes below.

- Read this manual carefully before using the equipment.
- To prevent accidents, adhere strictly to the instructions and keep clear of moving parts at all times.
- Follow instructions on all equipment labels at all times. Replace any damaged labels immediately.
- Ensure that only qualified personnel perform maintenance and service on the unit.
- When replacing parts, be sure that only genuine Savaria parts are used.
- This unit is intended for use by a mature person who understands its proper operation as set out in this manual.
- Prior to operation, make sure that:
 - All doors and gates are locked and secure.
 - All areas in and around the lift are clear of any obstructions.
 - All lights are functioning properly.
- Test your keys and emergency stop button every month.

1. DESCRIPTION

Figure 1 shows the exterior components of the Multilift.

Figure 1

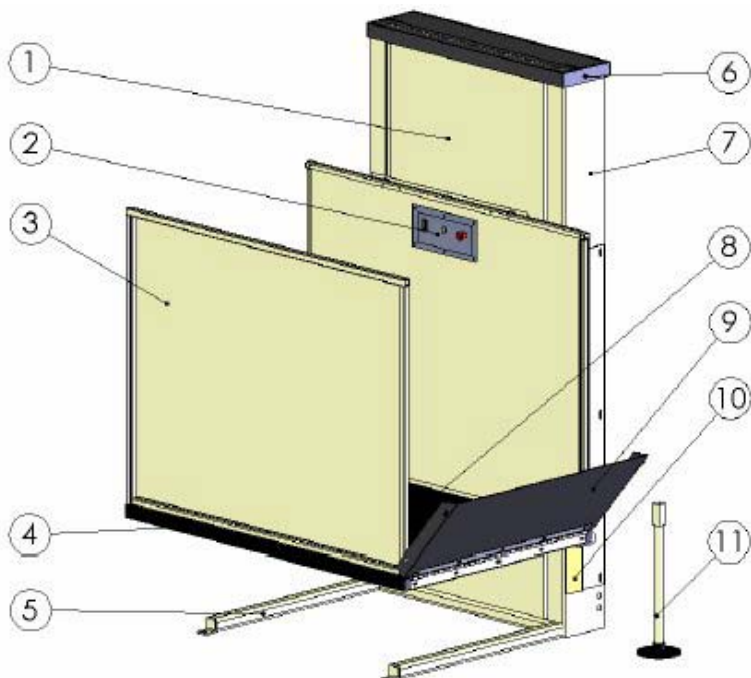

Number	Description	Number	Description
1	Front tower panel	7	Tower
2	Car operating panel (C.O.P.)	8	Non-skid platform
3	Side guard panel	9	Automatic access ramp
4	Safety underpan sensors	10	Access ramp channel
5	Self support base	11	Manual lowering device
6	Tower cover	-	-

2. GENERAL SPECIFICATIONS

Multilift Specifications

Applications	Residential (indoor/outdoor); commercial (U.S.A.)
Load capacity	750 lb (340 kg)
Maximum travel	48" (1219 mm); optionally 72" (1829 mm)
Levels serviced	2
Travel speed	8 ft/min (0.04 m/s)
Daily cycle	Normal: 10 Heavy: 25 Excessive: 40 Maximum starts in 1 hour on standard installation: 10
Platform sizes	34" x 48" (863 mm x 1219 mm) 34" x 54" (863 mm x 1371 mm) 34" x 60" (863 mm x 1524 mm)
Side guard panels	42" (1067 mm) side guard panels on platform
Cab access	Front/rear access (platform Type 2) 90 degree access (platform Type 3 and 4)
Power supply	120 VAC, 20 A, 60 Hz, single phase
Drive system	Acme screw and back-up nut 1 hp (0.75 Kw) motor, 110 VAC Optional 1/2 hp, 12-volt battery model available
Control system	Electronic-free relay logic controller
Finish	Beige electrostatic powder coat paint on all steel surfaces and vacuum-formed plastics
Features	Call/send stations at landings Continuous-pressure type buttons Operating control buttons on platform Manual lowering/raising device Low-voltage controls Underpan sensors Non-skid platform surface Automatic access ramp Emergency stop button Optional 12-volt battery model

3. OPERATION

Attendant Operation

- The attendant shall only operate the lift from the call station located at the lower landing if the lift is unenclosed.
- The attendant shall have full view of the floor area under the lift and of the rider at all times.
- If the lift is enclosed, the lift can be operated from the upper landing provided the operator has view of the rider at all times.
- During attendant operation, the car directional controls must not be operational.

Operating from the COP Controls

Figure 2 shows the Multilift car operating panel (COP).

Figure 2

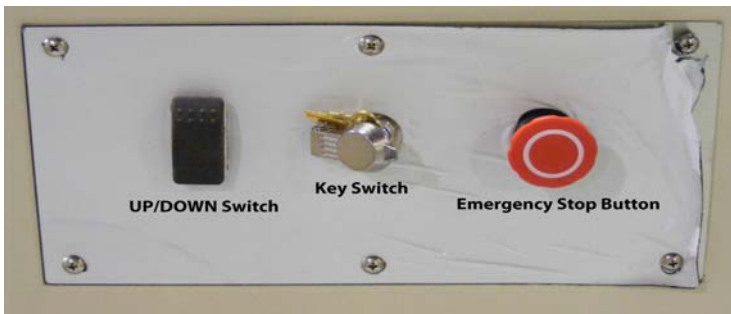

To operate the Multilift from the COP controls:

- 1** Insert the key into the key switch and turn it to the ON position to activate the operating buttons.
- 2** Apply constant pressure on the UP/DOWN switch (as required) to move the platform to the desired landing. Note that the Multilift will not move if one of the doors /gates is open.
- 3** When the lift reaches the landing, the door will unlock automatically (for units with mechanical GAL locks). For units with an electric strike, the door will unlock automatically for a few seconds when the lift reaches the landing. If you need to re-open the door after the delay, turn the key to the ON position and press the call button again to unlock the door.

- 4 To prevent unauthorized use of the lift, take the key out when the unit is not in operation.
- 5 Pressing the Emergency Stop button during travel will stop the lift immediately and activate the alarm (if equipped). The Emergency Stop overrides the landing station controls. Pull the Emergency Stop out to return the lift to normal operation.
- 6 If the COP has an optional Alarm button, pressing the Alarm button during travel will activate the alarm. **If the door is locked at a landing, you can press the Alarm button to unlock the current landing door.**

Operating from the Landing Station Controls

Figure 3 shows the landing station (hall call) controls.

Figure 3

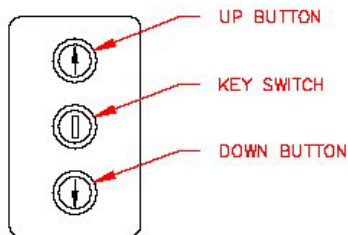

To operate the Multilift from the landing (call/send) station controls:

- 1 Insert the key into the key switch and turn it to the ON position to activate the operating buttons.
- 2 Apply constant pressure on the appropriate button to call the platform to the desired landing. Note that the Multilift will not move if one of the doors/gates is open.
- 3 When the lift reaches the landing, the door will unlock automatically (for units with mechanical GAL locks). For units with an electric strike, the door will unlock automatically for a few seconds when the lift reaches the landing. If you need to re-open the door after the delay, turn the key on and press the call button again to unlock the door.
- 4 To prevent unauthorized use of the lift, take the key out when the unit is not in operation.

4. ADDITIONAL FEATURES

Platform Gate

The platform gate is shown in Figure 4. This feature is optional for residential use and required for public applications. The gate must be in the fully closed position for the lift to operate.

Figure 4



Safety Underpan

The safety underpan (shown in Figure 5) is located under the platform. The underpan has sensors that detect any obstacles and stop the downward travel of the lift. This is optional on enclosed units and required on other units.

Figure 5

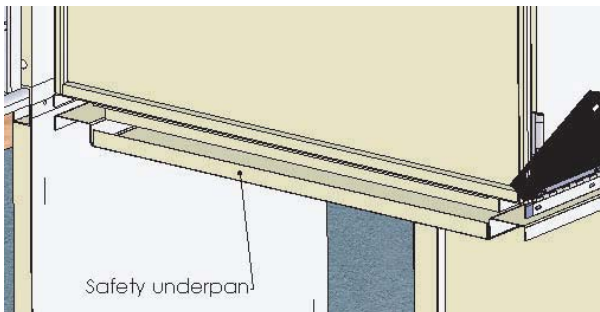

Door Locks

The door lock keeps the door/gate locked when the platform is moving and not at a landing.

NOTE

Keys are for emergency use only and should always be kept in a safe place for use by trained personnel only.

Emergency Door Opening

For units with a **WR-500 lock**, the door can be opened manually using the emergency key provided (Figure 6).

Insert the key into the lock and turn it a half turn clockwise to unlock the door. Pull the door open and then turn the key a half turn counter-clockwise to remove it from the lock.

Figure 6

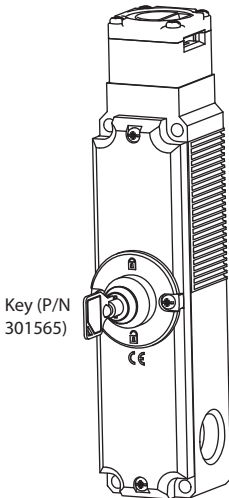

For units with a **GAL lock**, the door can be opened manually using a special key inserted into the round pin on the front of the lock (Figure 7).

Figure 7

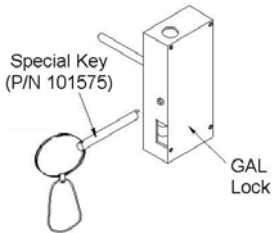

For units with an **electric strike** on a door provided by Savaria, the door can be opened manually using a 1/4" Allen key inserted through the hole in the front of the door (Figure 8).

Figure 8

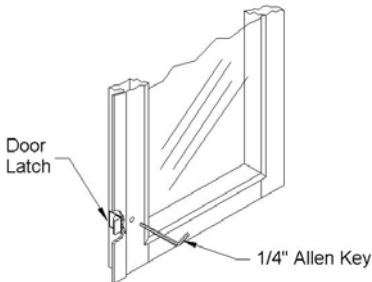

For units with an electric strike on a door provided by others, contact your Authorized Savaria Dealer for the appropriate instructions.

NOTE

After use of any emergency function (access key or manual lowering device), ensure that all doors/gates are secure and locked. While the emergency function is in use, DO NOT leave the area unattended.

Emergency Stop Button

Pressing the red Emergency Stop button during travel will stop the lift immediately and activate the alarm (if equipped). The Emergency Stop overrides the landing (call/send) stations. Pull the Emergency Stop out to return the lift to normal operation.

Manual Lowering Device

In case of an emergency, you can lower the platform manually using the hand crank provided (Figure 9).

Take off the cap and insert the hand crank as shown in Figure 9. Turn the hand crank to move the platform to the desired position at the lower landing. Remove the hand crank and put the cap back on.

NOTE

This mechanism is for emergency use only. After use of any emergency function (access key or manual lowering device), ensure that all doors/gates are secure and locked. While the emergency function is in use, DO NOT leave the area unattended.

Figure 9

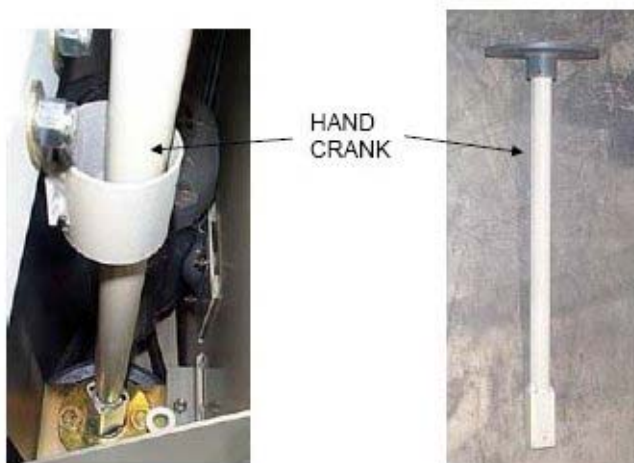

5. MAINTENANCE

NOTE

The owner can perform the 2-month inspections, but the 6-month inspections **must** be performed by a Qualified Technician. Contact your Authorized Dealer.

Units installed in adverse environments will require additional maintenance on a monthly basis

IMPORTANT: Please test the phone in your elevator during every maintenance. If the phone is inactive, please shut down the elevator until the phone line is active. This applies to all lifts in a hoistway or enclosure models.

Maintenance Schedule

Verification by owner	Frequency
Verify general operation of the lift.	Every 2 months
Verify correct operation of the safety devices: <ul style="list-style-type: none"> Underpan safety switches Door contact Door lock Emergency stop 	Every 2 months
Verify correct operation of the phone (where applicable).	Every 2 months
Verification by technician ONLY	Frequency
Verify the following: <ul style="list-style-type: none"> General operation of the lift Operation of the underpan sensors Operation of the emergency stop Operation of the door and gate lock contacts. The lift should not run unless the door or gate is closed and locked. 	Every 6 months
Verify the door lock operation: <ul style="list-style-type: none"> The lift is operational when the door is locked The lift is NOT operational when the door is open at a landing Insert the lock key to manually unlock the door and ensure the following: <ul style="list-style-type: none"> The lift is NOT operational when the door is manually unlocked with the key The key cannot be removed from the lock when the door is manually unlocked 	Every 6 months
Verify that all hardware is tightened.	Every 6 months
Check the rollers (function and wear).	Every 6 months
Check the battery fluid level (optional system). Also check the voltage with the charger unplugged (13 VDC unloaded and no lower than 10-11 VDC when running up/down).	Every 6 months

Verify the safety components: <ul style="list-style-type: none">• Operation and alignment of the up final limit switch (activate by hand)• Operation of the back-up nut switch• Operation of the load switch. Lower the platform to the ground using the hand crank to release the load on the main nut. The lift should not run up until you restore the load on the main nut by moving the platform up with the hand crank.• Operation of the up relays. Verify that neither of the two up relays gets stuck in the activated position. Use a multimeter to verify that every N.O. contact is open when the relays are not activated.	Every 6 months
Lubricate the acme screw, and upper and lower bearings using high-quality wheel bearing grease.	Every 6 months
Ensure that all filler panels (aluminum, Plexiglas or glass) are securely fastened in the enclosure, doors and gates.	Every 6 months

Operator Troubleshooting

The following table lists potential problems and their possible solutions.

If the problem persists, contact your Authorized Dealer.

Potential Problem	Possible Solution
Platform travels up but not down	Check the underpan sensor. Pull down on the underpan to ensure the pan is not stuck in the activated position.
Platform travels down but not up	Verify the charge and fluid level of the battery (battery operation only).
Platform does not move in either direction	Check that the key is ON (if applicable). Check that the doors are closed. Check to see if the Emergency Stop button is pushed in; it should be pulled out for normal operation. If the platform is at the top landing, check the underpan sensor as described above. Check the power supply (breaker, cord, etc.).

Multilift Vertical Platform Lift OWNER'S MANUAL

Part No. 000609
Copyright © 2018

Savaria Concord Lifts, Inc.
2 Walker Drive
Brampton, Ontario, L6T 5E1, Canada
www.savaria.com

For service or questions about this product, please contact your installing dealer.

DEALER NAME: _____

DEALER PHONE: _____

